



DIAMOND SERIES

Industrial pumps

DV Short / DV Long series



Flanged Industrial Series

The Vertical series is the ideal solution for pumping from wells or tanks. It is suitable for pumping viscous and non-viscous products as well as abrasive or aggressive ones.

Available with outlet flange connections UNI, DIN, ANSI and GAS BSP; the suction nozzle instead is made with a particular design optimized for priming the product in which it is lost in.

The length is totally customizable according to the setup requirements. The stainless steel version (AISI 304 or AISI 316) has a protective jacket that covers the stator as standard to prevent it from corrosion.

There are two standard configurations available: the short version and the long version.

The difference is in the length of the installation with which they are required for. The short version is compact, robust, easy to install.

The long version instead allows installation in deep wells or tanks and presents a complete series of dedicated optimizations such as the removable inlet for easy maintenance of the rotor, stator and coupling.

A fundamental characteristic is the support of the downhole support, with a guiding cone which makes the pump very stable and vibration free even in extreme conditions of use.

Both series are always configured in a monobloc arrangement.

- **DV Short version:** Compact. This version allows installation with only anchor plate.

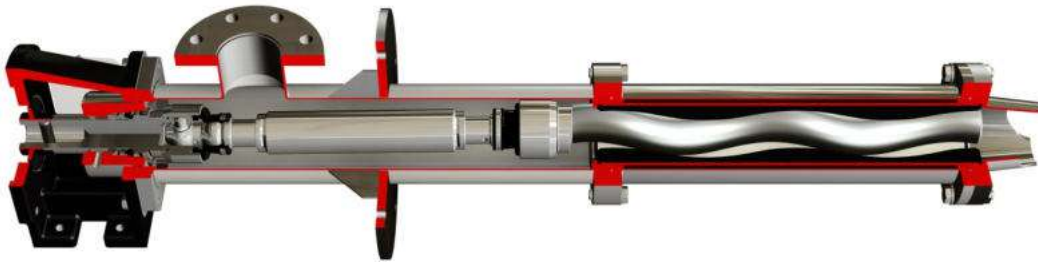

- **DV Long version:** This version requires to be fixed with a downhole support with the guiding cone to minimize the vibrations and oscillations of the pump caused by the considerable length of the pump itself.



Patented Pin Joint: The pin-type joint, the actual heart of the single screw pump, is the best solution of its type on the market. It offers greater durability, reliability and reduced maintenance costs, managing to combine extreme compactness with unrivalled strength. Its particular manufacturing enables the sub-division of axial loads and torque in different elements, making it one of a kind. As well as the above, replacement of worn parts is cheap thanks to the bushes in the worn zones, avoiding costly replacement of parts (rotor, drive shaft, and female drive shaft). To resist high pressure in the pump casing up to 12 bar, the pin can be hydraulically balanced.

(standard for DV Series).

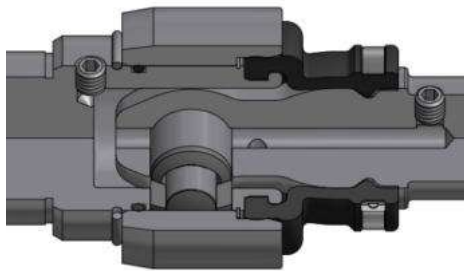

Cardan Joint: Cardan joint is the best solution for heavy application with high pressure inside the pump casing. It improves the allowable torque up to 4 times torque with the same pump size. It is available with internal metal joint protection to for an additional improvement of the rubber service life.

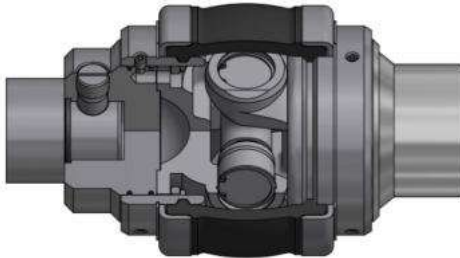

Modularity: The Diamond series is based on the concept of modularity in every characteristic: hydraulic parts, casing, seals, base plates, housing, drive shafts. Each part can be manufactured in a series of variants without changing the structure of the machine, while keeping the main spare parts standard.



Materials: The parts in contact with the product of the DV Diamond Series pumps can be manufactured in various materials. From the version in cast iron to stainless steel (AISI 304 and AISI 316), as well as other materials on request such as Duplex and Super Duplex. Also, in the version in cast iron, the rotating parts are still manufactured in stainless steel AISI 420 or on request in AISI 304 / AISI 316.

Low pulsating flows: Tensional stress and pulsating flow are very low. The centrifugal effect is reduced to a minimum thanks to the low operating speeds and mainly the axial development of the pump.

Base plates: The bottom supports, characterized by considerable thicknesses, are very strong. Available in carbon steel or stainless steel.

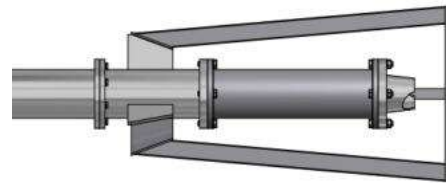

Shaft sealing: Different sealing systems can be installed. Each solution is suitable to the specific application. The types available are: single acting mechanical seal, with quench, double acting mechanical seal back to back or tandem, Gland packing with or without flush.

Seals type are interchangeable on the standard pump. Each solution was carefully engineered taking into consideration all the operating conditions. As well as changing the sealing system, you can also install various types of mechanical seals based on the application.

The compartments are suitable for installation of the seals manufactured according to the standards ISO EN 12756. As well as this, it is possible to use cartridge seals from the main manufacturers, also available according to standards API 682 category 1+2

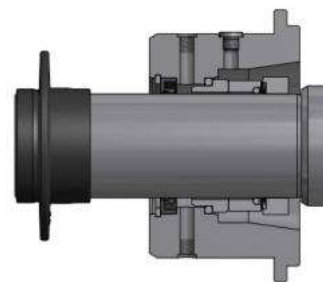

<p>Performance: Duration, efficiency, reliability and low consumption. With the Diamond series, we have reached the maximum levels of technological development in every aspect.</p>	<p>Versatility: The Diamond series was designed to be versatile whatever its use. For this reason, it can be set up with various options and accessories suitable for every field of application. As well as the above, the peculiar features of the single screw pump are naturally taken advantage of with various types of fluids pumped, from low to the highest viscosity, clean and containing solids varying in size and nature.</p>
<p>Efficiency: Maximum performance level, exceptional operating efficiency thanks to the optimum volumetric yield and high pressure and its consumption reduced to a minimum. All the Diamond series hydraulic efficiencies were calculated to guarantee the maximum found on today's market.</p>	<p>Quality Each part is manufactured according the highly restrictive quality specifications. Finishes and precision of each part are the basis of each pump manufactured. All parts are subject to specific controls based on their characteristics and functionality.</p>
<p>Motorizations: All the drives which are installed on the Diamond series have been tested for long periods and subject to strict and rigorous technical checks. We can install both electric and hydraulic motors.</p> <p>All the models of reducers and variators offer specific characteristics in terms of strength, size of the bearings and the quality of the gears.</p>	

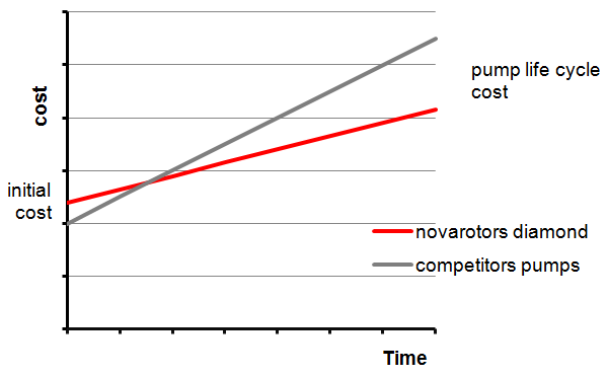

Maintenance: The Diamond series is designed to ensure easy maintenance and normally require the replacement of a minimum number of components. In particular the joint bushes are able to be replaced without having to replace shafts and rotors. The costs of maintenance are greatly reduced. The cost of the pump, considered in over its full life cycle, is highly competitive.

<p>Cost / benefit: The Diamond series, thanks to the compactness of its elements, combines technical success without comparison at very competitive costs. The modularity allows you to offer the right solutions depending on the application whilst avoiding paying for features you do not need, all adding to its competitiveness.</p>	<p>Self-priming: The peculiarities of the hydraulic parts of the progressive cavity pump allow excellent self-priming (up to 7m). The Diamond series was designed to create the minimum loss possible in the pump body, thanks to large cross sections and a compact joint design and fluid dynamics.</p>
---------------------------------------------------------------------------------------------------------------------------------------------------------------------------------------------------------------------------------------------------------------------------------------------------------------------------------------------------	------------------------------------------------------------------------------------------------------------------------------------------------------------------------------------------------------------------------------------------------------------------------------------------------------------------

Ease of installation: The Diamond series pumps are easy to install due to compactness, simplicity of operation and operational flexibility thanks to the various features included above.

Detailed documentation: Each pump comes with clear and detailed operating instructions. Orders are followed by experienced and qualified staff that integrates in providing detailed documentation on demand and specific for the product supplied.

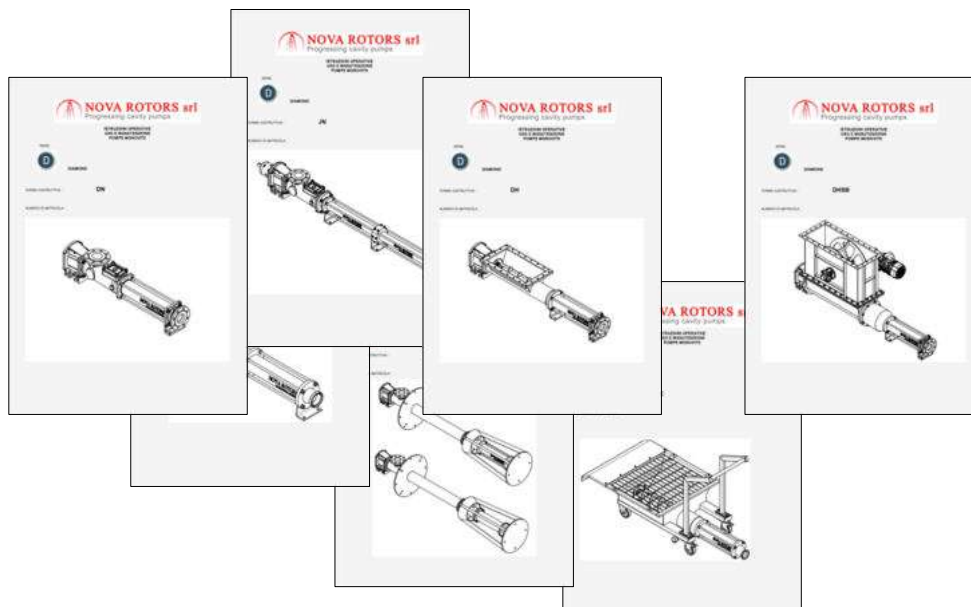

Detailed characteristics

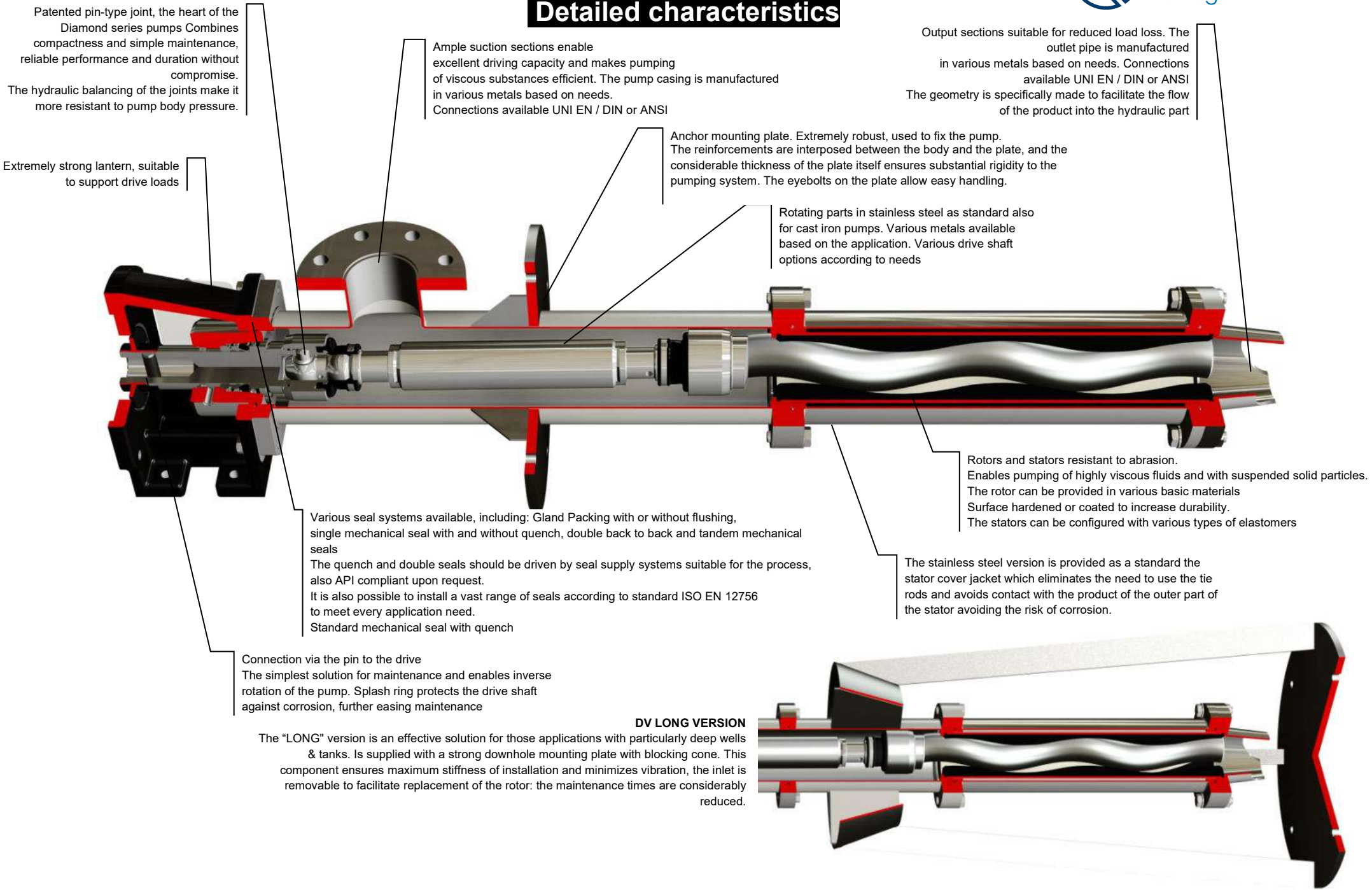

Patented pin-type joint, the heart of the Diamond series pumps. Combines compactness and simple maintenance, reliable performance and duration without compromise. The hydraulic balancing of the joints make it more resistant to pump body pressure.

Extremely strong lantern, suitable to support drive loads

Ample suction sections enable excellent driving capacity and makes pumping of viscous substances efficient. The pump casing is manufactured in various metals based on needs. Connections available UNI EN / DIN or ANSI

Output sections suitable for reduced load loss. The outlet pipe is manufactured in various metals based on needs. Connections available UNI EN / DIN or ANSI. The geometry is specifically made to facilitate the flow of the product into the hydraulic part

Anchor mounting plate. Extremely robust, used to fix the pump. The reinforcements are interposed between the body and the plate, and the considerable thickness of the plate itself ensures substantial rigidity to the pumping system. The eyebolts on the plate allow easy handling.

Rotating parts in stainless steel as standard also for cast iron pumps. Various metals available based on the application. Various drive shaft options according to needs

Various seal systems available, including: Gland Packing with or without flushing, single mechanical seal with and without quench, double back to back and tandem mechanical seals. The quench and double seals should be driven by seal supply systems suitable for the process, also API compliant upon request. It is also possible to install a vast range of seals according to standard ISO EN 12756 to meet every application need. Standard mechanical seal with quench

Rotors and stators resistant to abrasion. Enables pumping of highly viscous fluids and with suspended solid particles. The rotor can be provided in various basic materials. Surface hardened or coated to increase durability. The stators can be configured with various types of elastomers

The stainless steel version is provided as a standard the stator cover jacket which eliminates the need to use the tie rods and avoids contact with the product of the outer part of the stator avoiding the risk of corrosion.

Connection via the pin to the drive. The simplest solution for maintenance and enables inverse rotation of the pump. Splash ring protects the drive shaft against corrosion, further easing maintenance

DV LONG VERSION
The "LONG" version is an effective solution for those applications with particularly deep wells & tanks. Is supplied with a strong downhole mounting plate with blocking cone. This component ensures maximum stiffness of installation and minimizes vibration, the inlet is removable to facilitate replacement of the rotor: the maintenance times are considerably reduced.

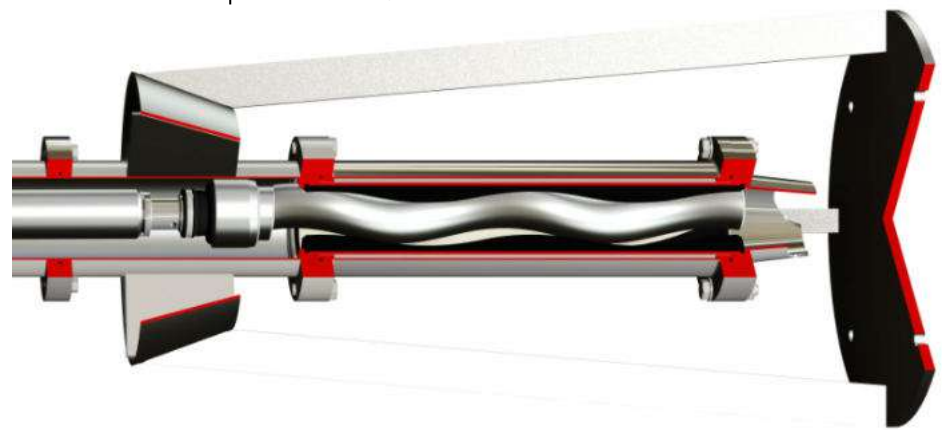

VERSION AND OPTION

Casing material

Base materials:

S275JR, AISI 304, AISI 316

Materials of the sealing shaft

Base materials:

AISI 420, AISI 304, AISI 316, F51(Duplex), F55 (Super Duplex)

Titanium

Hastelloy C276

Coatings:

Hardened Chrome plated HCP

Chrome oxide plasma (ceramic coating)

Rotor material

Base materials:

AISI 420, AISI 304, AISI 316, F51(Duplex), F55 (Super Duplex)

Titanium

Hastelloy C276

Heat treatments:

Hardening induction (only on AISI 420)

Coatings:

Hardened Chrome plated HCP

Chrome oxide plasma (ceramic coating)

Tungsten carbide HVOF

Stator material

Base materials:

NBR, food grade NBR, white NBR food grade

EPDM, EPDM food grade, white EPDM food grade

FPM, FPM food grade

HNBR, HNBR food grade

SYLICON

Buna-N (available on select models on request)

HYPALON (available on select models on request)

PTFE (available on select models on request)

Base plates

Bottom downhole plate with fixing cone.

Specific custom fixing system on request.

(For details, see the brochure constructive options, equipment and installations)

Connections

Flange UNI 2278 PN16 for pumps at 1 and 2 stage

Flange ASME B16.5 #150 for pumps at 1 and 2 stage

Threaded connection GAS BSP

Sealing system

Gland seal with flushing B02 (flush required)

Single mechanical seal with Quench Q0K9 (buffer-Quench-pot required)

Back-to-back double mechanical seal D0K9 (pressurized flushing required)

Tandem double mechanical seal K0K9 (buffer / flush required)

Single or double cartridge seals also in API 682 version category 1 and 2

Seal supply systems are available also in accordance with API Plan

(For construction details, see the brochure sealing systems and seals)

Optional for coupling rod

Joint Protection

Balanced hydraulic joint (standard)

Cardan Joint

(For details, see the brochure constructive options, equipment and installations)

Protection devices

Flow switch

Pressure switch

Flanged overpressure valve

(For details, see the brochure constructive options, equipment and installations)

Control devices

Control panel

Control panel with inverter

Drive with integrated inverter

(For details, see the brochure constructive options, equipment and installations)

Equipment and optional

Stator cover jacket in stainless steel (standard in the stainless steel series)

Quench Pot flushing

Stainless Steel Lantern

Hermetic Lantern

Carter to protect the motorization

Separate suction pipe (standard on DV – Long)

Eyebolts

(For details, see the brochure constructive options, equipment and installations)

Certifications

CE

ATEX

API

FEATURES OF USE

Operating range

Flow

Up to 680 m³/h

Pressure

Up to 24 bar for the standard series (48bar for the series K8)

Temperature

from -40°C until to 150°C

Typical applications

- Sewage sludge
- Water Treatment
- Industrial sludge
- Detergents and product for chemical industry
- Product of papermaking industry
- Agriculture
- Product derived from petro-chemical
- Marine Industry

TABLE OF MODELS

Flow and pressure

Size	Model	Qmax 2 bar [m ³ /h]	rpm max	P max [bar]
D020	1L1	4,9	1400	6
	05K2	2,5	1400	12
	025K4	0,7	800	24
D025	2L1	6,9	1000	6
	1K2	9,4	1000	12
	05K4	1,5	800	24
	025K8	0,5	600	48
D030	4L1	11	800	6
	2K2	5,6	800	12
	1K4	2,2	600	24
	05K8	1	500	48
D040	10L1	16,5	600	6
	4K2	8,5	600	12
	2K4	3,7	500	24
	1K8	1,5	400	48
	16L1	23,5	600	6
	8K2	12	600	12
D060	20L1	28	500	6
	10K2	14	500	12
	4K4	5,7	400	24
	2K8	2,6	350	48
	30L1	33	500	6
	16K2	16,5	500	12
D120	40L1	43	400	6
	20K2	20	400	12
	10K4	10	350	24
	4K8	5	350	48
	60L1	63,5	400	6
	30K2	32	400	12
D300	80L1	76	350	6
	40K2	38	350	12
	20K4	15,4	300	24
	10K8	8,5	300	48
	120L1	110	350	6
	60K2	55	350	12
D400	160L1	140	350	6
	80K2	78	350	12
	40K4	33	300	24
	20K8	16	300	48
	240L1	230	350	6
	120K2	115	350	12
D500	320L1	220	300	6
	160K2	120	300	12
	80K4	66	250	24
	40K8	33	250	48
	480L1	315	300	6
	240K2	155	300	12
D600	640L1	460	300	6
	320K2	235	300	12
	160K4	100	250	24
	80K8	50	250	48
	960L1	680	300	6
	480K2	340	300	12

